



ELITE SCREENS

Electric Wall/Ceiling Projection Screen
Saker Tab-Tension Series
User's Guide

Important Safety & Warning Precautions

Make sure to read this user's guide and follow the procedures below.

Caution: The screen's Black Top Drop is already set to its maximum drop limit. There is NO extra black-matte drop material on the roller. Please be aware that altering the vertical limit switch to drop the screen material off the roller voids your warranty with Elite Screens®. Unapproved changes or modifications (except for cutting the power cord for hardwire installations) to this unit are prohibited and will likewise void your warranty.

For more information, please contact our Technical Support Department at (877) 511-1211 Ext. 604.

- Please retain this user's guide for future reference.
- To avoid damaging the unit, do not use with any unauthorized accessories not recommended by the manufacturer.
- Handle the unit carefully during transportation to avoid any damages.
- To ensure safe and reliable operation, make sure the power connection is secure.
- The power source should be close to the unit and easily accessible.
- Do not install the unit on uneven, or inclined surfaces;
- To avoid electrical shock or product damage, do not install this device in a damp place.
- Do not place any heavy objects over the power cord.
- Position the power cord properly to avoid creating a trip hazard.
- Avoid electrical shock or fire, by not overloading the power cord.
- The internal & external parts of this unit are not end user serviceable. Do not attempt to disassemble this unit by yourself. Consult an authorized technician instead.
- Make sure the power source that this unit is connected to has a continuous power flow.
- If there is need to use an extension cord, make sure said cord has a compatible power rating.
- Do not handle this or any other electrical device if you are wet or standing in water.
- Whenever the screen reaches its end of life, follow local environmental guidelines regarding its proper disposal.

Do not use this unit under the following circumstances.

- Disconnect the power cord if exposed to moisture, rain, wind, electrical storms or snow.
- Avoid exposure to direct sunlight or any of the conditions stated in the previous bullet point.
- Keep away from fire or other high temperature heat sources.
- Cut off the power supply first before attempting maintenance or removal.
- Do not attempt to use this screen if there are obvious signs of damage.
- To avoid possible injury and/or an electric shock, do not attempt to use the screen if there is obvious damage or if there are any evident broken parts.

WARNING

Individual modifications to this product are prohibited and will void the manufacturer's warranty. Please contact the Elite Customer Service Team with any questions.

NOTE:

This equipment has been tested and found to comply with the limits for a Class B digital device, pursuant to Part 15 of the FCC Rules.

The product settings are designed to provide reasonable protection against any radio interference within a residential installation. If properly installed, the Saker Tab-Tension screen may suffer from RF interference from other home electronics.

Although radio interference affecting other household electronics is unlikely, the following steps can be taken should RF interference occur.

- ✓ **Reorient or relocate the receiving antenna on the device that may be causing the interference.**
- ✓ **Increase the distance between the screen and the interfering device's receiver.**
- ✓ **Connect the projection screen to another power source apart from the interfering device.**

Pre-Installation





1. Carefully unpack the screen.
2. Always handle the screen upright on a clean, level surface.
3. Keep the screen out of contact with foreign particles such as dust, sawdust, and/or liquids.

NOTE

Regardless of the mounting method, each screen should be securely installed so that vibrations or pulling on the viewing surface will not cause the casing to become loose or fall. Included are complimentary mounting screws that may or may not be appropriate for the installation you are attempting. Always use the correct anchors to safely secure the screen and always consult a professional integrator.

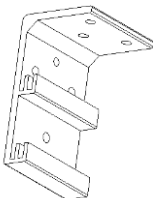
Hardware Parts List

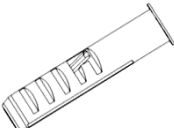
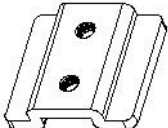
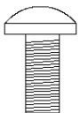
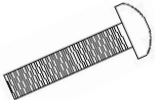
Please make sure all parts listed below are included before proceeding with the installation.

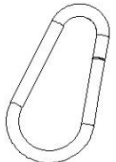
A. Wall/Ceiling mount bracket x2	B. M5x60 Screw x6	C. M12 Dry-wall anchor x6	D. Bracket connector x2 (Installed on the housing)
			
E. M5x11 Bolt Screw x4 (Screw on the D parts)	F. M5x25MM round head cross screws x2	G. M5x30MM eyebolt screw & M5 nut x2	H. Snap link x2
			

Installation Instructions

For installation assistance, please consult a professional Installer. EliteScreens is not liable for faulty installations.

A. Wall Mount

Flush hidden mount (movable position)

This mount method allows the screen to slide horizontally.

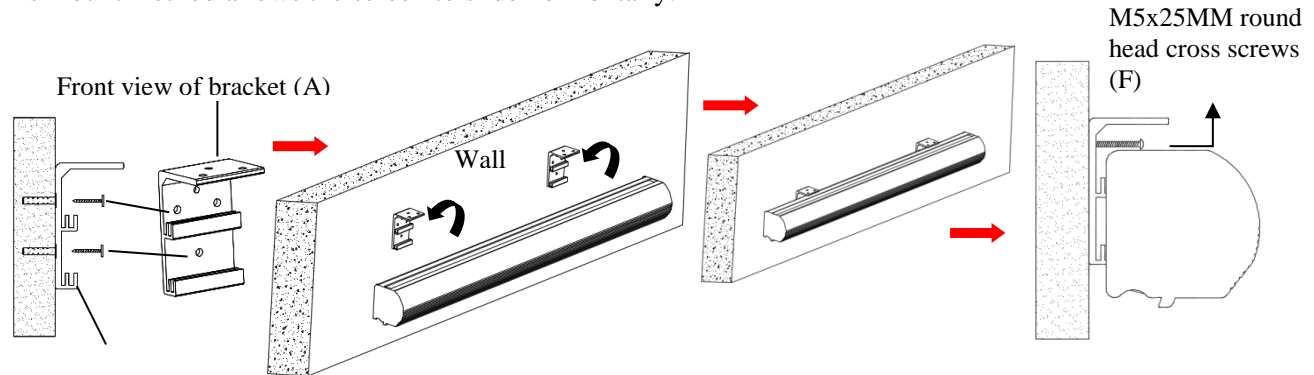

1. Determine where the screen will be installed. Then, measure and mark the distance between the top and bottom screw holes from each **Wall/Ceiling mount bracket (A)**.
2. Drill a hole on all marked points and install the brackets with the **dry-wall anchor (C)**, **M5x60 screw (B)**, Make sure both brackets are properly leveled.
3. Hang the screen by placing the **lower** “catch” located on the back over the bracket's **upper** “catch”.
4. After making sure the screen is secured, you can slide it left / right to properly center it in position.
5. Lastly, screw the **M5 screw (F)** into the upper hole of the bracket to add additional support for the screen.

Two or more people are required while one holds the screen in place.

B. Ceiling Mount

I. Ceiling Mount (movable position)

This mount method allows the screen to slide horizontally.

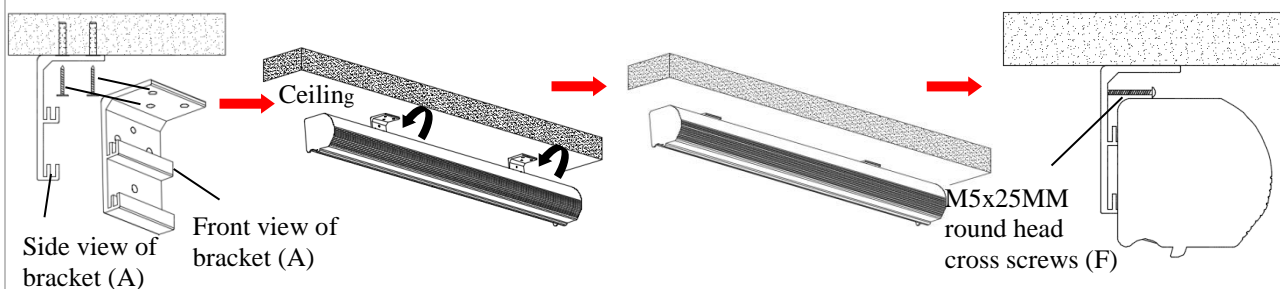

1. Determine where the screen will be installed. Then, measure and mark the distance between the top and bottom screw holes from each **Wall/Ceiling mount bracket (A)**.
2. Drill a hole on all marked areas and install the brackets with the **dry-wall anchor (C)**, **M5x60 screw (B)**, Make sure both brackets are properly leveled.
3. Hang the screen by placing the **lower** “catch” located on the back over the bracket's **upper** “catch”.
4. After making sure the screen is secured, you can slide it left / right to properly center it in position.
5. Lastly, screw the **M5 screw (F)** into the upper hole of the bracket to add additional support for the screen.

Two or more people are required while one holds the screen in place.

II. Suspended

1. Screw the **eyebolt (G)** onto the **bracket connector (D)**.
2. Attach the **snap link (H)** through the **eyebolt (G)** and connect it to the ceiling eyebolt screw (not included) as rated for the screen's weight.

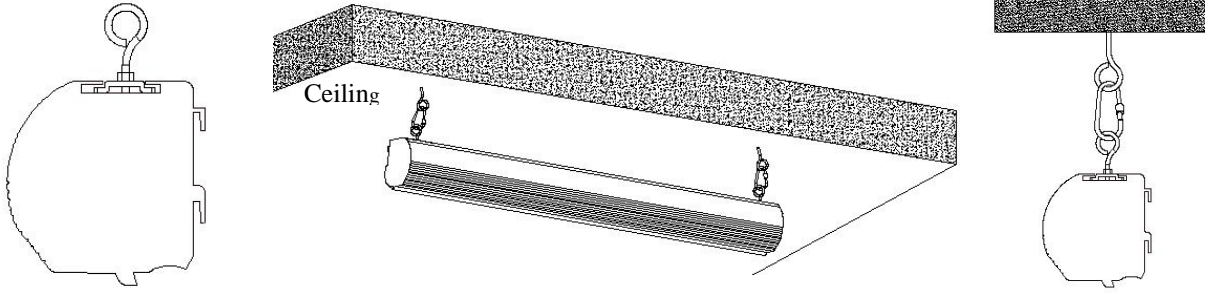



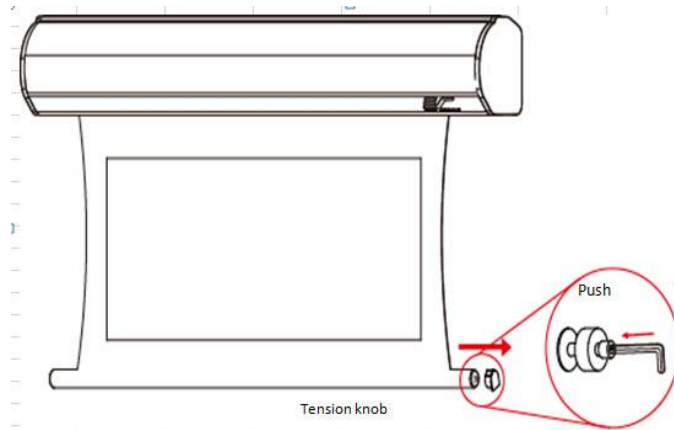

Screen material tension adjustment (4mm Allen Wrench required and not included)

Remove the weight bar end cap to expose the adjustment tension knob. This knob has a 4mm Allen port. Insert your 4mm Allen Wrench and push in the adjustment tension knob, turn clockwise and your screen will gain more tension. Turn the Allen Wrench counter clockwise and the screen will lose tension. Please note this adjustment is not necessary as the tension of the screen has been pre-set to its factory drop setting. If you would like to adjust the screen tension, please contact Elite Screens® for assistance to avoid damaging the screen and voiding your warranty.

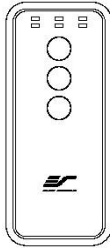

Saker Tab-Tension Series | Controls and Accessories

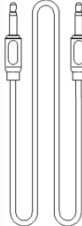
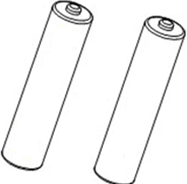
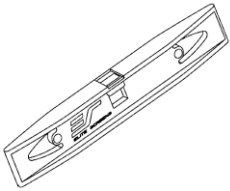
A. IR Remote	B. RF Remote	C. Wall switch control box	D. 5-12 volt trigger cable
			 Red 12V Green 0V
E. IR extended "eye" receiver	F. Wireless 5-12v trigger cable	G. AAA batteries	H. Bubble leveler
			

Screen operation

Electric Current: Depending upon region, your Elite Screen will operation 100v, 110v, or 220v voltage.

1. After ensuring the power outlet & screen are compatible (voltage), plug the power cord into the power outlet.
2. Once the screen has power, you'll be able to control it using any of the 6 methods described below.

6 ways to control your Saker

1. **IR remote control (Item A, Fig 1)**: The Infrared functions by direct line of sight contact using a beam range of 30 feet. Aim the IR remote at the circular window located on the left side of the screen.

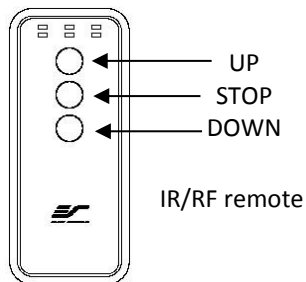

Fig.1

2. **IR "Eye" Receiver (Item E, Fig 2)**: The IR "Eye" Receiver plugs directly into the screen's RJ-45 input to present a low-profile line-of-sight control option for your IR remote control. It is an extended eye-receiver to accommodate a recessed ceiling installation..

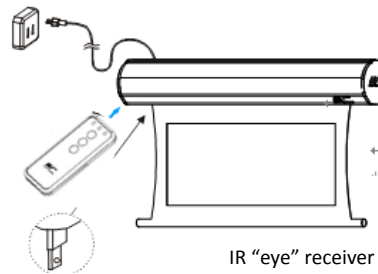

Fig.2

3. **RF Remote Control (Item B)**: The radio waves eliminate the need for a direct line of sight and has a range of 100 feet.

4. **3-Way Wall Switch (Item C, Fig 3)**: The 3-way wall switch is a wall mounted control box with an up/stop/down button. It plugs directly into the screen's RJ-45 input.

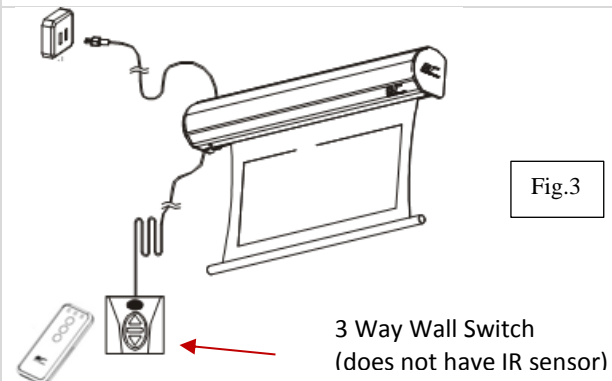
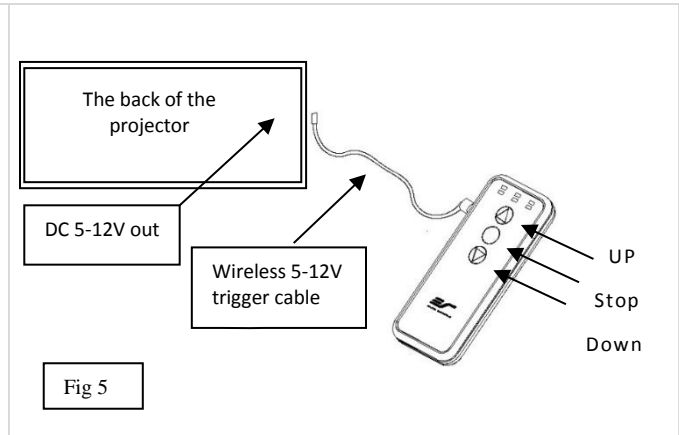
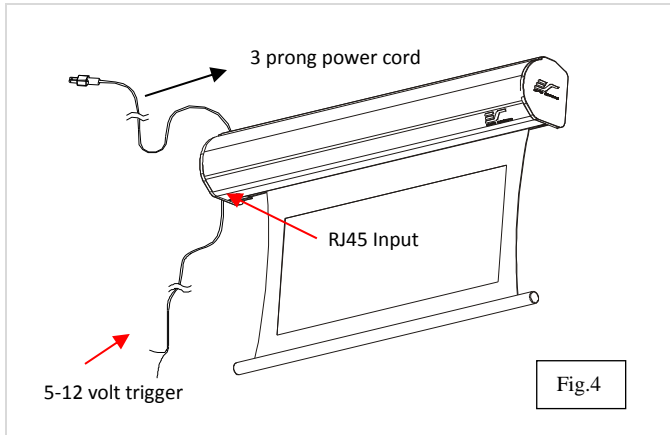

Fig.3

5. **5-12 volt trigger (Item D, Fig 4)**: The built-in 5-12V trigger input allows your screen to synchronize its drop & rise with the projector's power cycle. The screen deploys when the projector powers up and will retract when the projector powers down. The 5-12 volt RJ45 cable connects to your projector's trigger output via a separate cable that may or may not be provided by the manufacturer of the projector. The trigger feature will not work without an output cable from the projector, but it can be tested by connecting the Red (+) and Green (-) cable to a 9-volt battery.

6. **Wireless 5-12 volt trigger (Item F, Fig 5)**: The RF remote control serves as a dual purpose, independently as a handheld remote control, or as a Wireless 5-12 volt trigger using the trigger cable. The radio frequency technology can be programmed to send a wireless signal that synchronizes screen drop & rise with the projector's power cycle.



Here's how to set up your Wireless 5-12 volt trigger | Synchronization Instructions

- Step 1:** Connect one end of the 3.5 mm wireless 5-12 volt trigger cable to the RF remote.
 - Step 2:** Connect the other 3.5 mm end of the wireless 5-12 volt trigger cable to your projector
 - Step 3:** Make sure to unplug your screen from the power outlet
 - Step 4:** Hold the UP button on your RF remote
 - Step 5:** While holding the UP button, plug the screen back to the power outlet
 - Step 6:** Wait 5 seconds and then release the UP button
 - Step 7:** Your 5-12V wireless trigger should now be activated with your screen and ready to be used and able to control your screen with your projector's power cycle
- Repeat the steps again if not successful.
- (Please be aware, the projector on/off cycle may take longer to fully activate. It usually takes around 20-30seconds for full off and on cycle each time)*

For the following videos please visit:

- Ceiling Installation Video – www.elitescreens.com/sakertabceilinginstall
- Wireless Trigger Demonstration Video - www.elitescreens.com/sakertabtriggerdemo

For more information, technical support or your local EliteScreens® contact, please visit www.elitescreens.com