

COPENHAGEN

HI-FI furniture

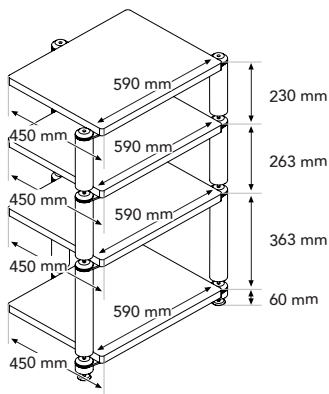

DIMENSIONS



MAXIMUM LOAD

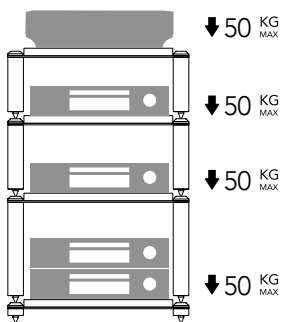

MODULE TYPE

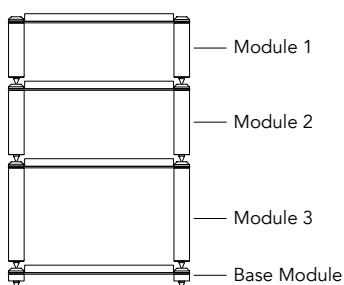

DESCRIPTION

The Copenhagen, Norstone's new modular furniture unit, stands out for its top-of-the-range construction and elegant design.

Comprising four modules of different sizes, it is perfectly suited to the needs of audiophiles looking for a solution that is both functional and aesthetically pleasing.

Its white oak tops add a natural, refined touch, while its solid metal frame ensures great strength and stability.

Each module is fitted with spikes and counter-spikes to eliminate unwanted vibrations. It's ideal for housing any Hi-Fi equipment, from amplifiers to vinyl turntables, while adding a modern touch to your listening space.



MODULE 1

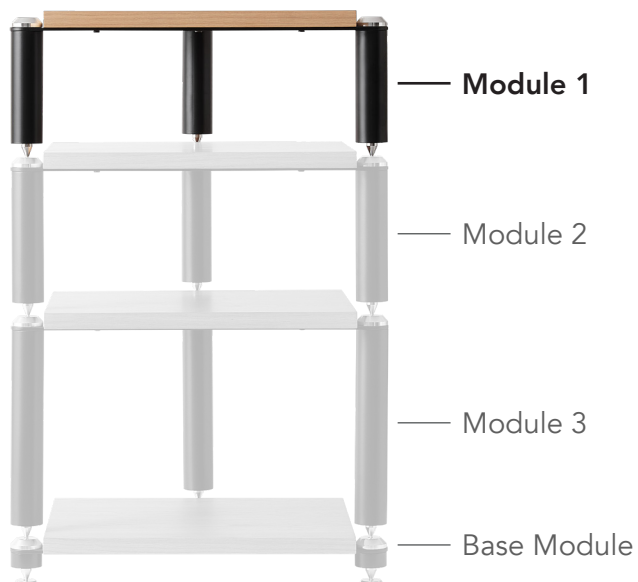

DESIGN

Finish : *Oak*

Structure : *Solid metal*

MAXIMUM LOAD

Module 01 : *50 kg*

DIMENSIONS UTILES

Module 01 : *W590 x H230 x D450 mm*

PACKAGING

Delivered disassembled with screws kit , mounting instructions and tools

Quantity / box : *NA*

Type : *NA*

Dimensions : *NA*

Gross weight : *NA*

Net weight : *NA*

PRODUCT CODE

MODULE 1



FINISH : *Oak*

EAN : 3700795181102

SKU : NORCOP1AOK



MODULE 2

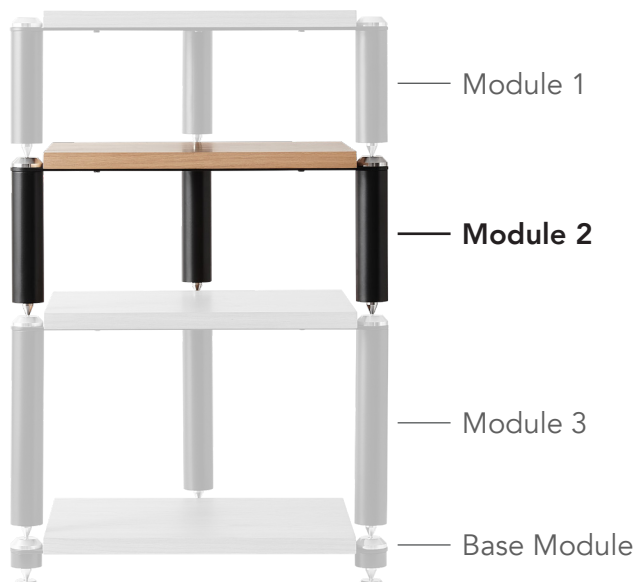

DESIGN

Finish : *Oak*

Structure : *Solid metal*

MAXIMUM LOAD

Module 02 : *50 kg*

DIMENSIONS UTILES

Module 02 : *W590 x H263 x D450 mm*

PACKAGING

Delivered disassembled with screws kit , mounting instructions and tools

Quantity / box : *NA*

Type : *NA*

Dimensions : *NA*

Gross weight : *NA*

Net weight : *NA*

PRODUCT CODE

MODULE 2



FINISH : *Oak*

EAN : 3700795181119

SKU : NORCOP2AOK



MODULE 3

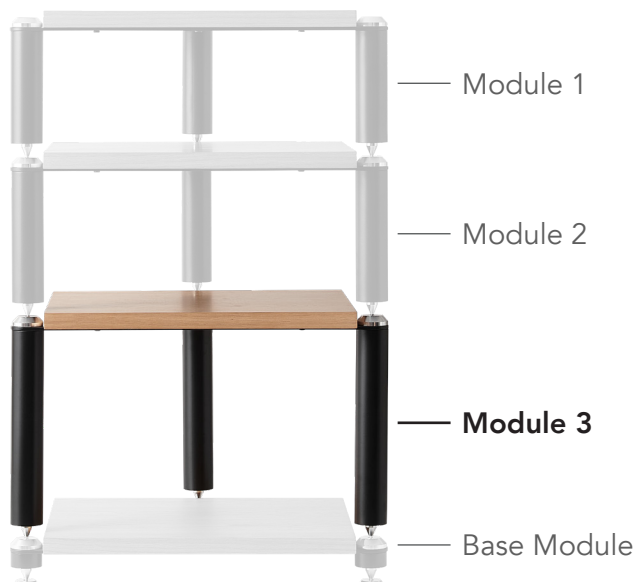

DESIGN

Finish : *Oak*

Structure : *Solid metal*

MAXIMUM LOAD

Module 03 : *50 kg*

DIMENSIONS UTILES

Module 03 : *W590 x H363 x D450 mm*

PACKAGING

Delivered disassembled with screws kit , mounting instructions and tools

Quantity / box : *NA*

Type : *NA*

Dimensions : *NA*

Gross weight : *NA*

Net weight : *NA*

PRODUCT CODE

MODULE 3



FINISH : *Oak*

EAN : *3700795181126*

SKU : *NORCOP3AOK*



BASE MODULE

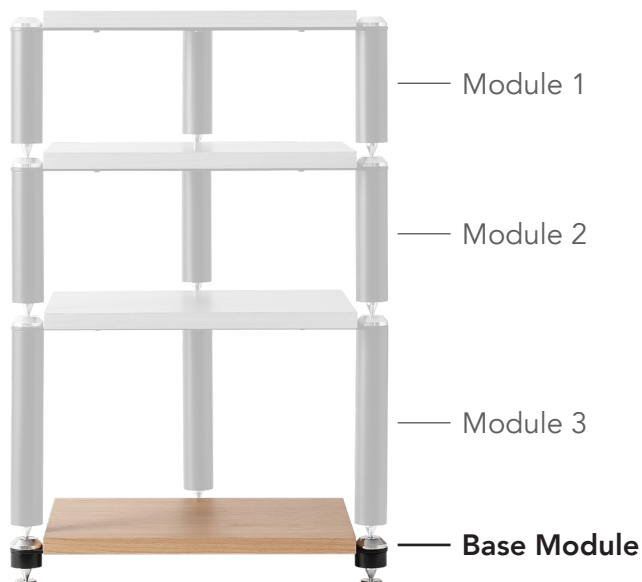

DESIGN

Finish : *Oak*

Structure : *Solid metal*

MAXIMUM LOAD

Base Module : *50 kg*

DIMENSIONS UTILES

Base Module : *W590 x H60 x D450 mm*

PACKAGING

Delivered disassembled with screws kit , mounting instructions and tools

Quantity / box : *NA*

Type : *NA*

Dimensions : *NA*

Gross weight : *NA*

Net weight : *NA*

PRODUCT CODE

BASE MODULE

FINISH : *Oak*

EAN : 3700795181096

SKU : NORCOPBASAOK

